

6 MODUL VERTIKÁLNĚ MOUNTING SYSTEM

BN-EW-6x20-15

bragen **PV** system
powered by MTComax

Materiál
S 350GD

Povrchová úprava
ZM 310 Magnelis

Záruka
10 let

Zatížení sněhem
ČSN EN 1991-1-3 1,2 kN/m²

Zatížení větrem
ČSN EN 1991-1-4 0,59 kN/m²

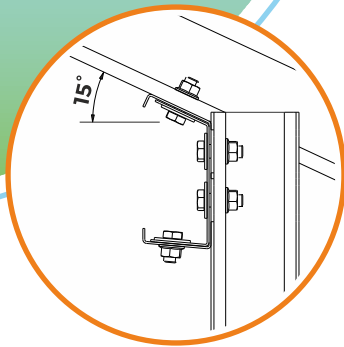
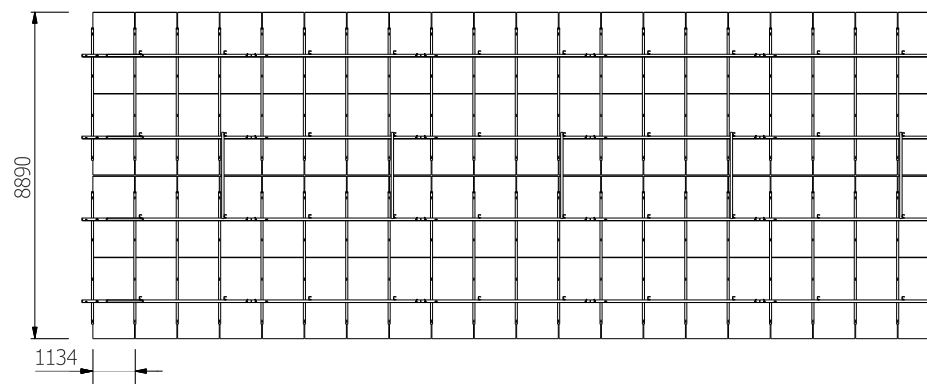
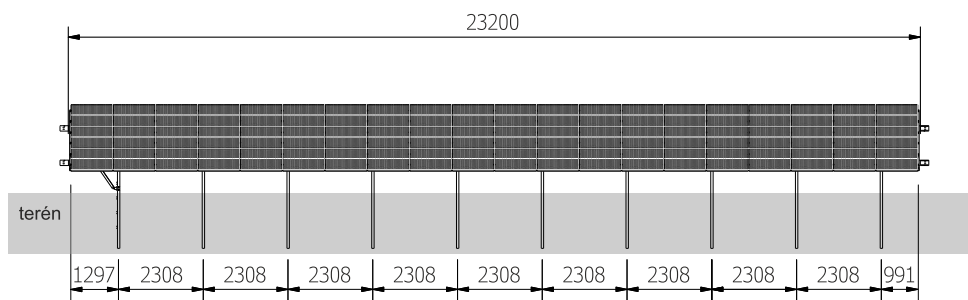
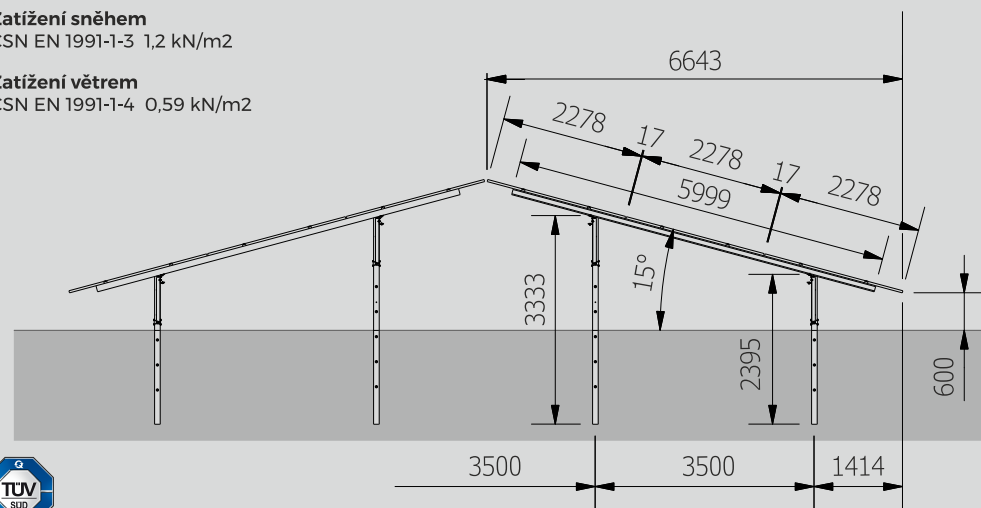
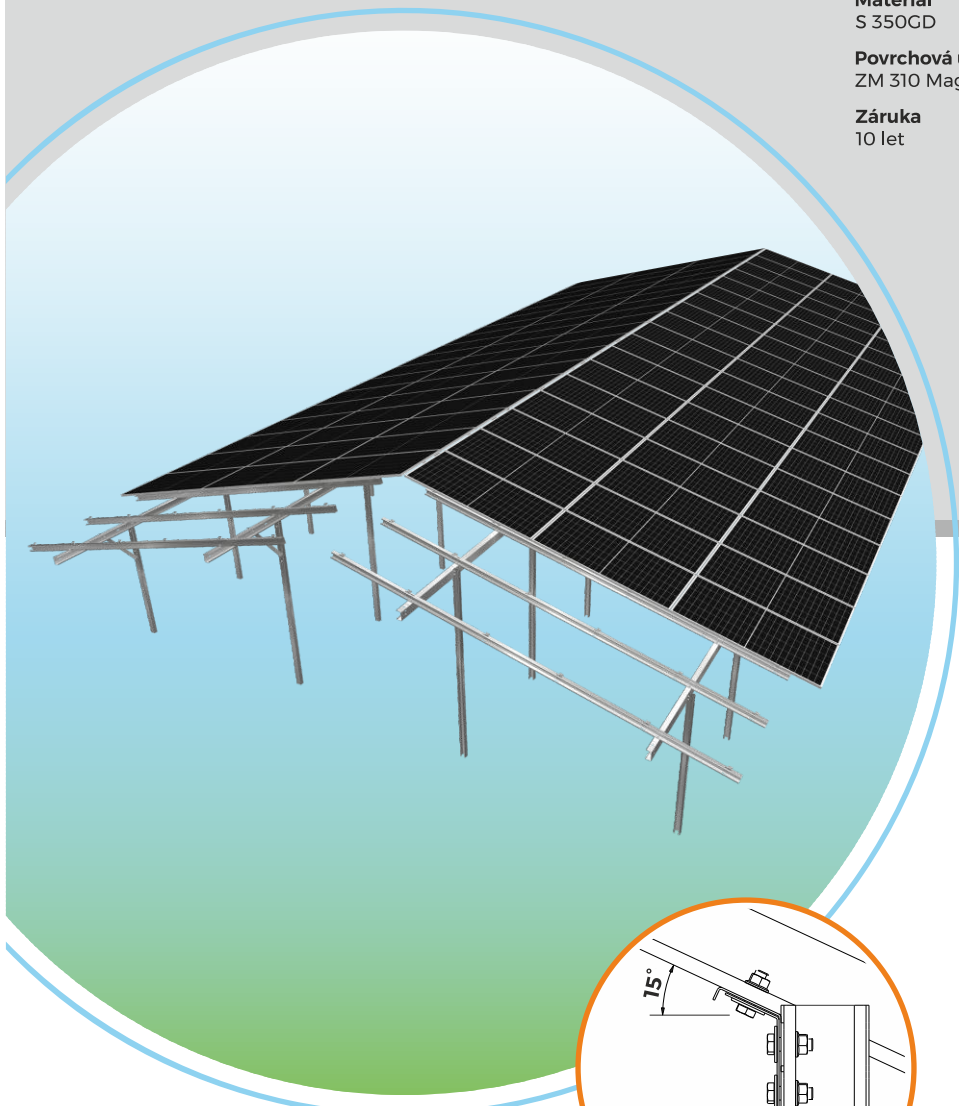

USPOŘÁDÁNÍ



ÚHEL



MONTÁŽ



www.bragen.cz